

Be sure to check out all the exciting products
Rush Creek has to offer. Visit our web site at:

www.triumphsportsusa.com



Warranty:

All of our products come with a one year warranty on all parts.

Manufacturer Defects:

Defective pieces will be replaced at no cost to you. Please e-mail to Customerservice@Triumphsportsusa.com with attached photos of the defective part and we will send replacements. PLEASE NOTE: Cracks in logs are not defects. They develop during the drying process of the logs and do not affect the stability of the game in any way, and lend to the rustic nature of your log game room.

If your product needs service, please be advised that Triumph Sports USA reserves the right to decline service when the product is found to be excessively worn, altered in any way, or when damage is caused by acts other than defective workmanship or materials. This warranty is void if the product has been subject to abuse. For service under this warranty, please contact Triumph Sports USA. You will need your receipt for proof of purchase.



Triumph Sports USA
Aurora, IL 60504
www.triumphsportsusa.com
Rush Creek is a trademark owned by Triumph Sports USA
©2007 Triumph Sports USA. All Rights Reserved.

Item # 37-0004
#37-0010



Rush Creek™

PUB CHAIR



Tools Needed For Assembly:

Screwdriver
Level

Assembly Tips:

Some drawings or images in this manual may not look exactly like your product. Please read and understand the text before starting each assembly step.

Using wood glue (included) to glue the joints after assembly will provide a stronger bond to the product.

If you are using an electric screw driver in assembly, please set at low torque and do not overtighten the hardware.







Care:

Apply lemon oil with a soft cotton cloth. Do not use products with silicones. This may cause damage to the finish. Never let the wood get in contact with any type of paint remover.

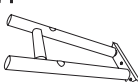
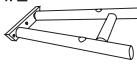
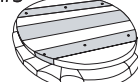
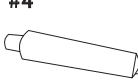
Connections:

Changes in temperature and humidity will cause the wood to dry out possibly causing the bolts loosen. Check the bolts periodically to make sure they are still tight. DO NOT put your wood game piece directly against hot radiators or sources of heat. Doing this may cause the wood to dry and crack.

Chair Parts List

#1  Leg Panel (a) 1 Pieces	#2  Leg Panel (b) 1 Pieces	#3  Seat 1 Pieces	#4  Leg Support 2 Pieces
#5  Wood Cap	#6  1/2" Washer 10 Piece	#7  Bolt 10 Pieces	#8  5/16" Washer 10 Piece
#9  Glue			

Stool Assembly

Step 1

Lay stool leg panels (#1&2) on the floor with the holes for leg supports facing each other. **NOTE:** Each leg panel and leg support are labeled A, B. Please correspond with stickers. See diagram.

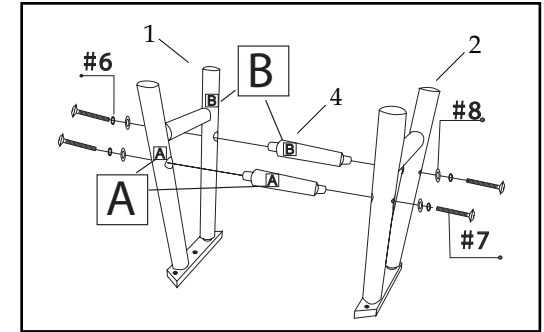

Step 2

Brush the end point of the leg support (#4) with glue, Push it into the holes on leg panels.

Step 3

When the leg support is firmly fitted, attach bolts (#7), 1/2" washers (#6) and 5/16" washers (#8) to the leg panel.

Step 4

Lay seat (#3) up side down on a smooth surface, position assembled leg on top of the seat and using bolts (#7), 1/2" washers (#6) and 5/16" washers (#8) tighten the stool. Using wood caps (#5) with glue (#9) to fill the holes.

